



**EX** *Exigo*<sup>®</sup>

**X70 RIGS**  
EXIGO-UK.COM



## CONTACT

**WEB:** [www.exigo-uk.com](http://www.exigo-uk.com)

**SALES:** 0870 850 1822

**INT'L:** +44 (0) 1706 633 560

**EMAIL:** [sales@exigo-uk.com](mailto:sales@exigo-uk.com)

## DISCLAIMER

Some images in this brochure feature auxiliary items such as weight plates and Olympic bars etc. which are for illustrative purposes only, and are not included with the product.

## CONTENTS

<b>ABOUT US</b> .....	<b>4</b>
<b>CERTIFICATIONS</b> .....	<b>5</b>
<b>MADE IN BRITAIN</b> .....	<b>6</b>
<b>OUR PROCESS</b> .....	<b>8</b>

<b>X70 RIGS</b> .....	<b>10</b>
<b>ATTACHMENTS</b> .....	<b>28</b>
<b>COLOUR OPTIONS</b> .....	<b>32</b>
<b>WARRANTY</b> .....	<b>33</b>





## ABOUT US

Established in 1995 by Founder and Managing Director Darren Golden, Exigo is the largest commercial gym equipment manufacturer in the UK and are recognised as a major source of quality products within the fitness industry. In more than 20 countries worldwide and an unrivalled product portfolio across Strength, Functional and Boxing.

**1995**  
ESTABLISHED

**30 000ft<sup>2</sup>**  
MANUFACTURING FACILITY

**+300**  
PRODUCTS

**+20**  
COUNTRIES

**5000ft<sup>2</sup>**  
R&D FACILITY

## CERTIFICATIONS

Exigo has attained ISO 9001:2015 for quality management standards, and our products are fully compliant with the current EN 957 and EN ISO 20957 Stationary Training Equipment standards.

Exigo are also an accredited CHAS Contractor. The industry-leading health & safety contractor certification in the UK.



## MADE IN BRITAIN

Exigo is renowned for manufacturing gym equipment and our commitment to excellence. We own our own product design, testing and manufacturing facility based in the UK, and are in full control of our own production and processes.

### BRITISH STEEL

All Exigo products are produced with British Steel. Our 100x50x3 ERW flat sided oval, is produced in the UK to BSEN 10305-3:2010 specification.

### BUILT TO LAST

At Exigo we understand purchasing gym equipment is a big investment, therefore all our products are built to last and are backed by an industry leading main frame lifetime warranty.

### QUALITY CONTROL

Our products are subject to rigorous in house testing, ensuring they are fit for purpose to meet the demands and expectations of our customers.

### CONTINUAL DEVELOPMENT

We are constantly creating and developing. Our culture of continuous improvement, innovation and learning permeates the entire organisation and means that we never stand still.

## OUR MISSION

We aim to provide a source of quality products and services that meet or exceed your expectations. You will find Exigo to be among the leading suppliers of products, support and services available in the industry today, yet you will not find us the most expensive. More of what you want for much less than you would expect to pay.

We recruit the very best welders and fabricators and provide genuine opportunities for them to develop their skills and move on within the business. As part of our commitment to quality, all Exigo products are supported by an industry leading lifetime frame and weld guarantee.

# DESIGN. MANUFACTURE. INSTALLATION.

The ability to control our manufacturing processes, means that we can design and custom-build commercial gym equipment to a level that our customers tell us is unrivalled in the industry.

## // 01

### JUST IN TIME COMPONENTS

Through third party supplier agreements we are now able to reduce our lead times down to a maximum of 7 days for any materials required.

## // 02

### PICK COMPONENTS

Using our bespoke production planning system, work can be accurately scheduled and all components are picked on demand.

## // 03

### TUBE MANIPULATION

The first stage of manufacturing requires us to bend and manipulate steel using one of our four CNC tube bending machines.

## // 04

### MIG WELDING

Our team of highly skilled welders can then assemble and weld all parts using MIG welding.

## // 05

### POLYESTER POWDER COAT

Products then go through a two stage cleaning and phosphate treatment process, before a polyester powder coat is applied.

## // 06

### ASSEMBLY & INSPECTION

Exigo products are pre-assembled and inspected prior to packing and despatch.

## // 07

### FLAT PACKED

Exigo products ship flat packed, the appropriate packaging not only ensures your goods arrive safely and securely but can also help to reduce shipping and transport costs.

## // 08

### DELIVERY & INSTALLATION

Our experienced installation team is dedicated to providing an excellent service and will ensure your install runs smoothly and your equipment is set up correctly.

## X70 RIGS

Our X70 Series offers rig solutions for all budgets and requirements, all of which are fully modular and can be used as a complete set-up or as a starting point that can be expanded when your facility or demands grow. Our X70 Rigs are made with 70x70x3mm uprights which are compatible with various attachments and storage shelves to allow numerous workout possibilities along with convenient accessory locations for the trainer or user.



## X70 COMPONENTS

Exigo X70 Rigs are ingeniously designed with standard components to create fully customisable solutions. This allows for seamless compatibility, enabling facilities to create a rig to suit specific training requirements. The core of all our rigs comprises sturdy uprights and joining arms to form a strong framework for guaranteed stability and reliability. Exigo X70 Rigs allow for custom configurations, easy expansion, and reconfiguration, this means you can easily add or replace elements to accommodate new exercises or training modalities.

### UPRIGHTS

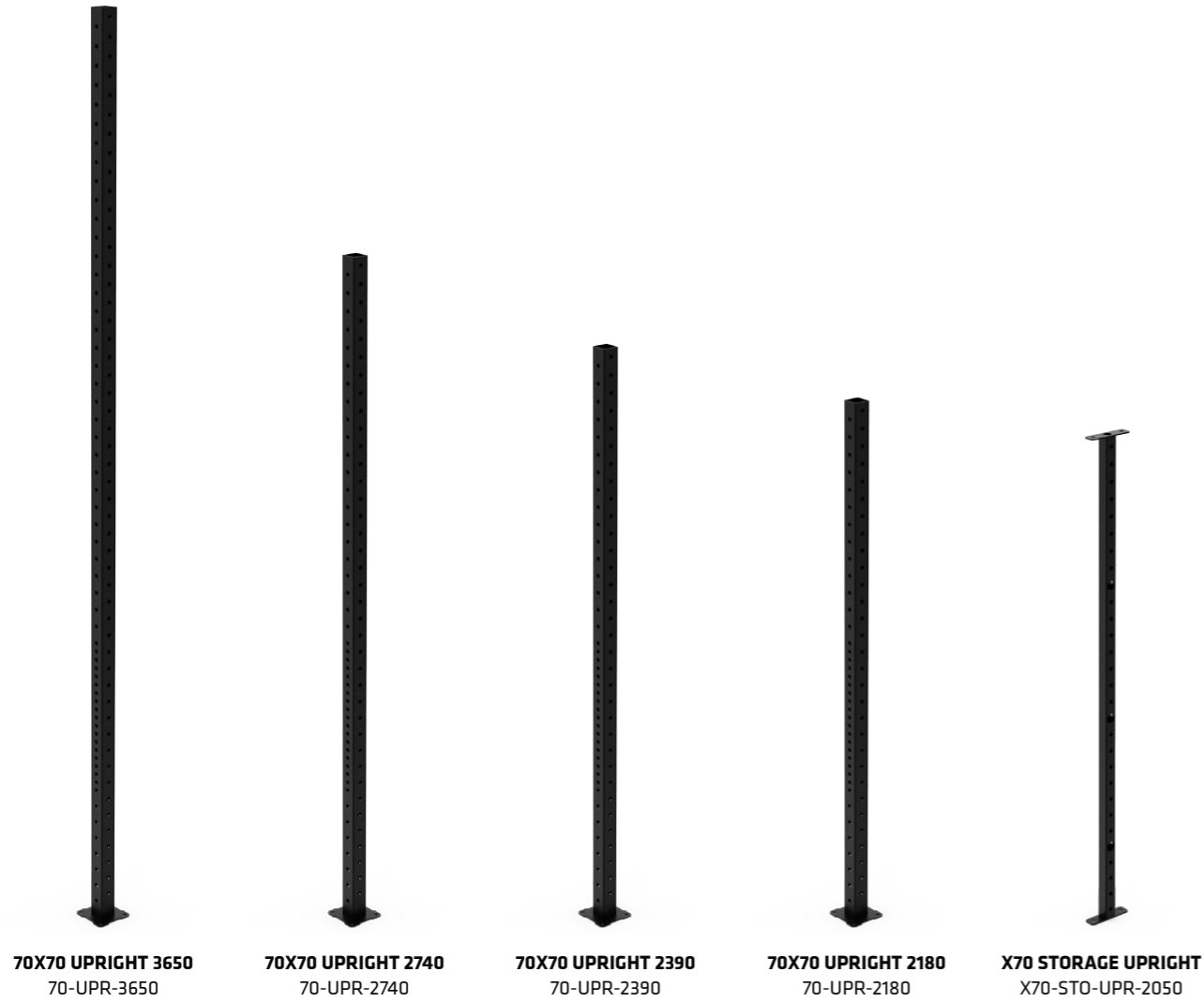

### JOINING SECTIONS



**EXIGO X70 2 BAY WIDE FREESTANDING RIG**



**EXIGO X70 2 BAY WIDE FREESTANDING HIGH/LOW RIG**



**EXIGO X70 4 BAY WIDE FREESTANDING RIG**

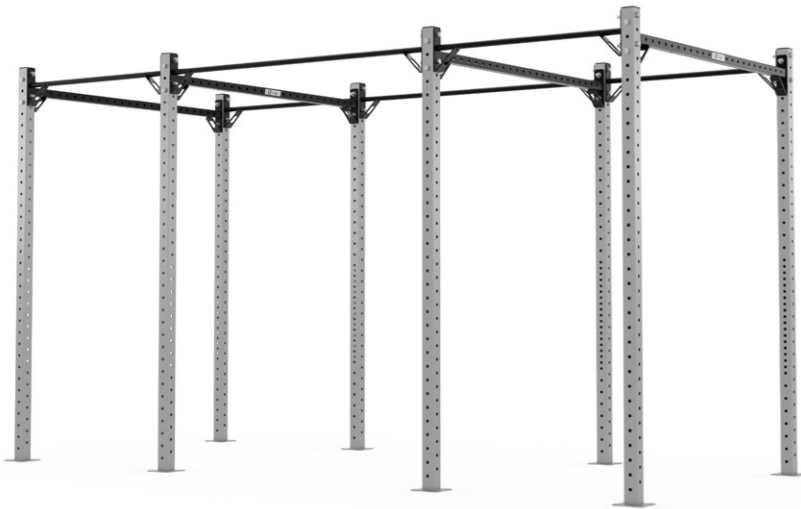

**EXIGO X70 4 BAY WIDE FREESTANDING HIGH/LOW RIG**

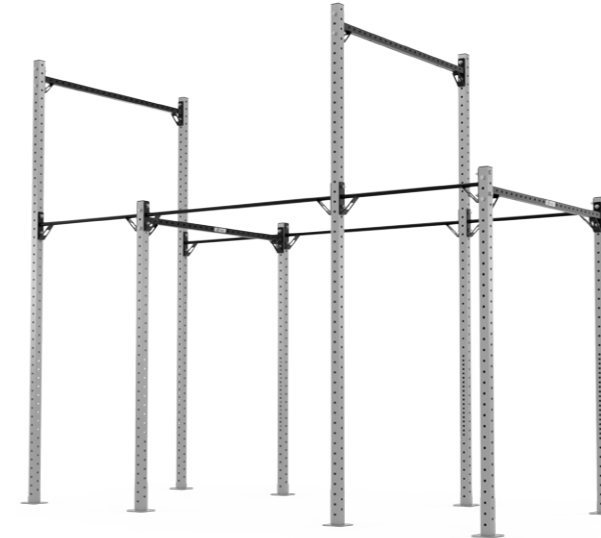

**EXIGO X70 6 BAY WIDE FREESTANDING RIG**

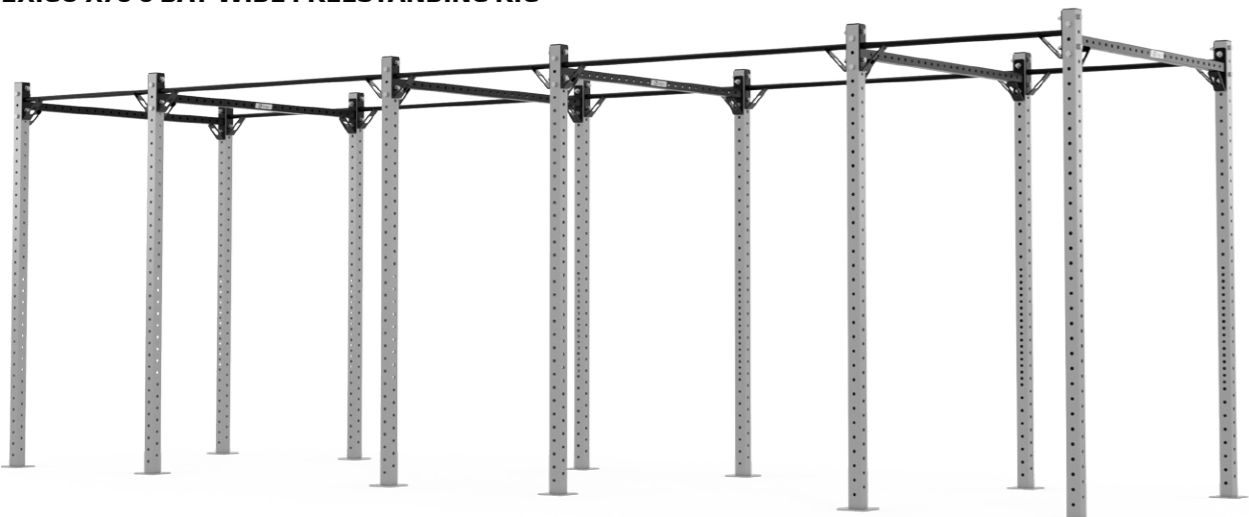

**EXIGO X70 6 BAY WIDE FREESTANDING HIGH/LOW RIG**

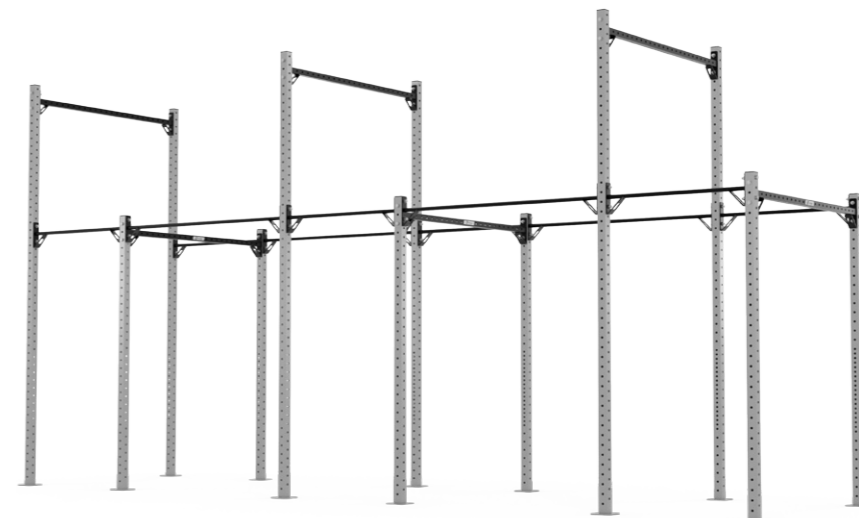



EXIGO X70 2 BAY FREESTANDING RIG

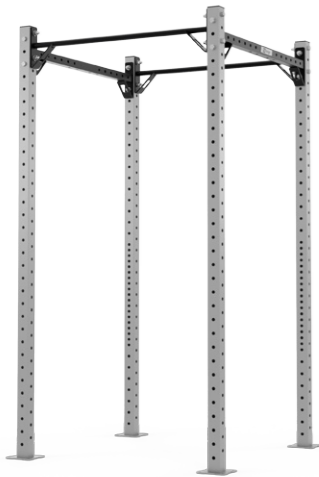

EXIGO X70 2 BAY FREESTANDING HIGH/LOW RIG



EXIGO X70 4 BAY FREESTANDING RIG

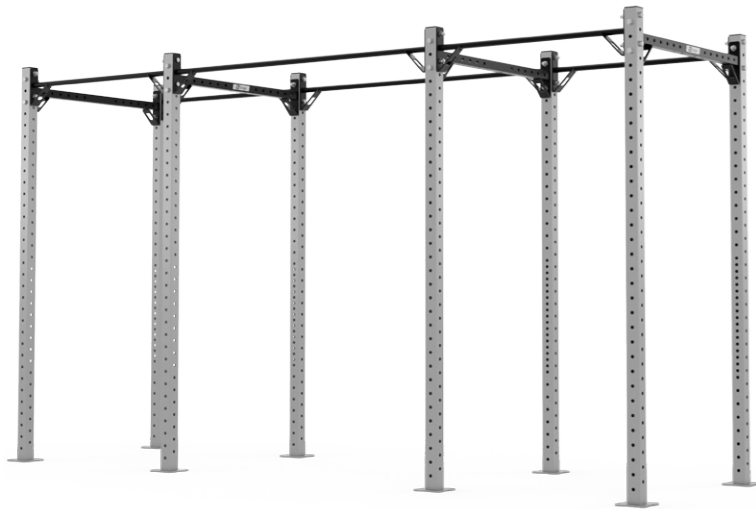

EXIGO X70 4 BAY FREESTANDING HIGH/LOW RIG



EXIGO X70 6 BAY FREESTANDING RIG

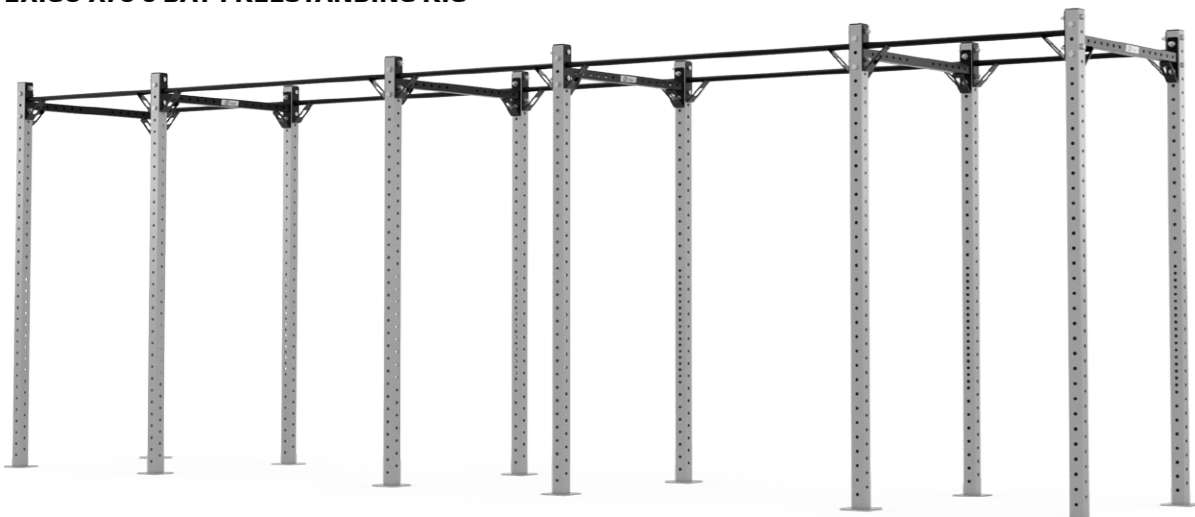

EXIGO X70 6 BAY FREESTANDING HIGH/LOW RIG

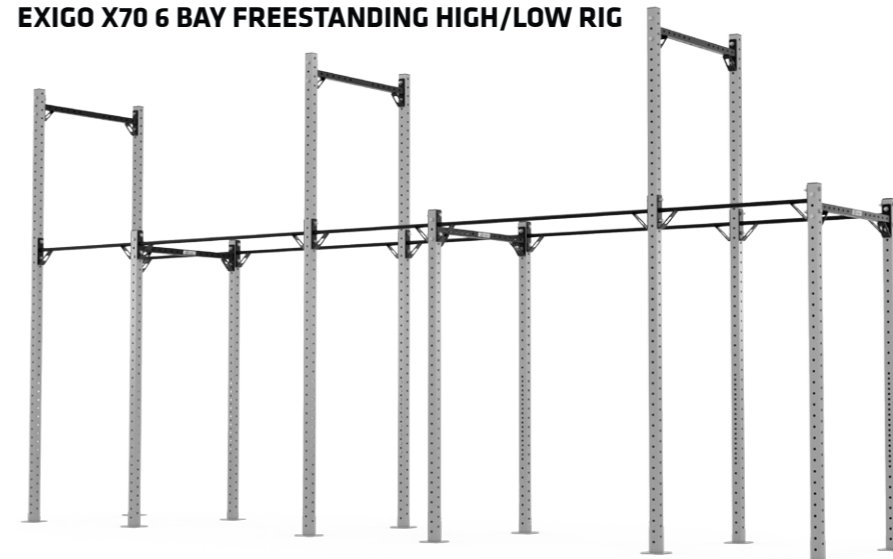

**EXIGO X70 2 BAY FREESTANDING STORAGE RIG**

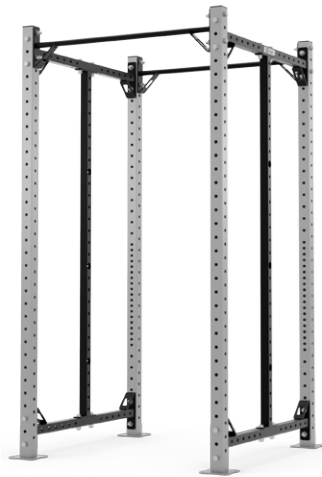

**EXIGO X70 2 BAY FREESTANDING HIGH/LOW STORAGE RIG**



**EXIGO X70 4 BAY FREESTANDING STORAGE RIG**



**EXIGO X70 4 BAY FREESTANDING HIGH/LOW STORAGE RIG**



**EXIGO X70 6 BAY FREESTANDING STORAGE RIG**



**EXIGO X70 6 BAY FREESTANDING HIGH/LOW STORAGE RIG**



EXIGO X70 1 BAY WALL RIG

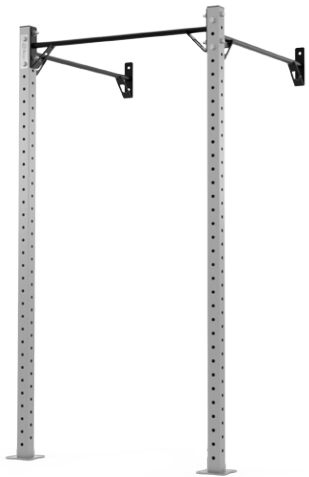

EXIGO X70 1 BAY HIGH/LOW WALL RIG



EXIGO X70 2 BAY WALL RIG

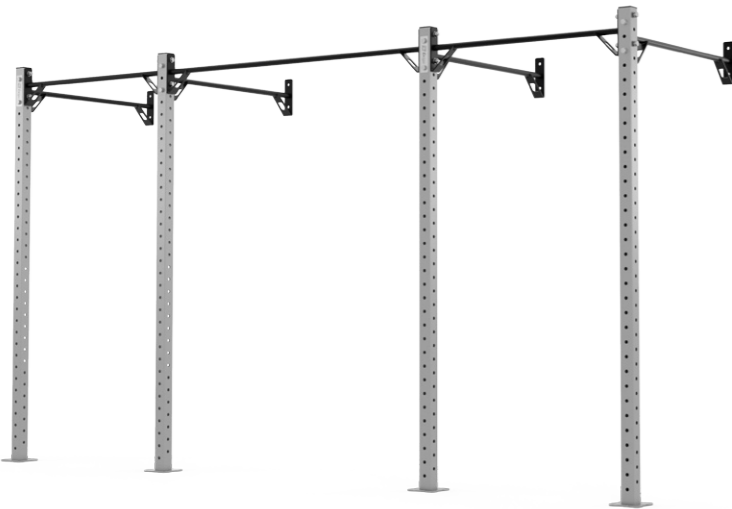

EXIGO X70 2 BAY HIGH/LOW WALL RIG



EXIGO X70 3 BAY WALL RIG

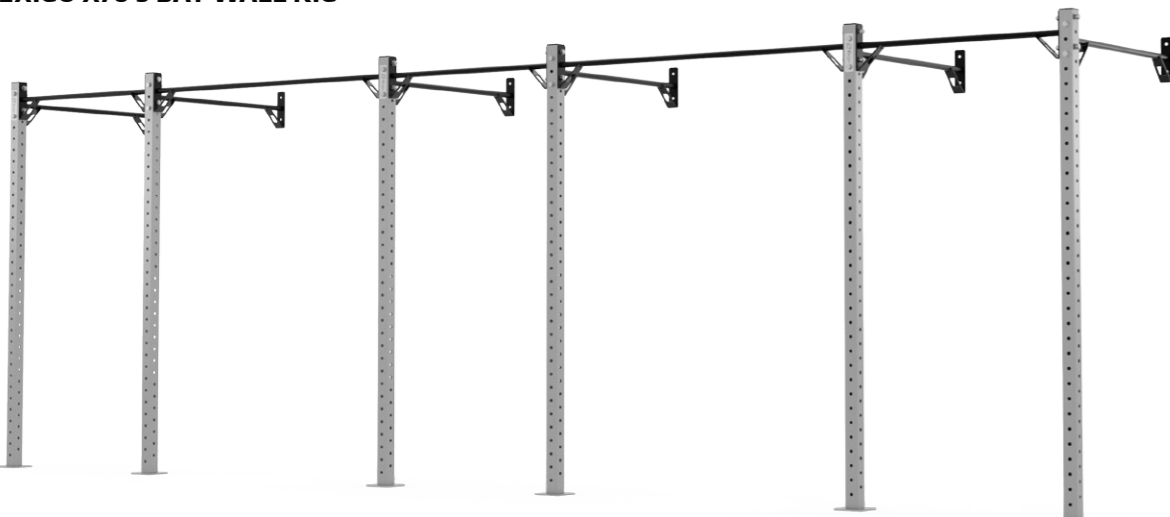

EXIGO X70 3 BAY HIGH/LOW WALL RIG

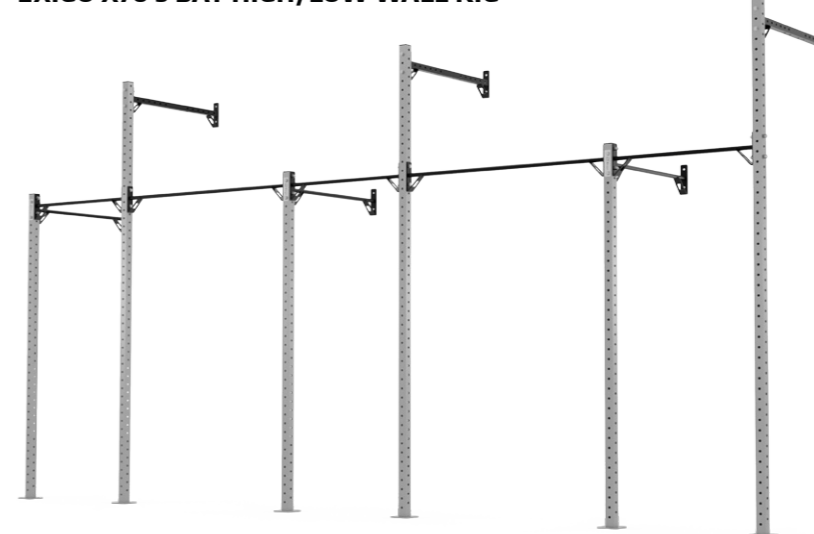

EXIGO X70 1 BAY COMPACT WALL RIG

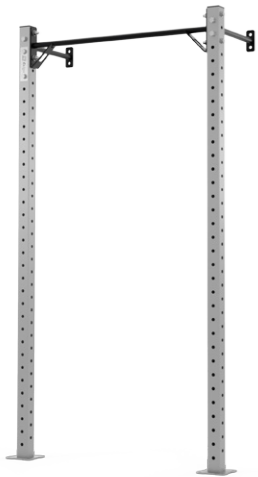

EXIGO X70 1 BAY COMPACT HIGH/LOW WALL RIG



EXIGO X70 2 BAY COMPACT WALL RIG

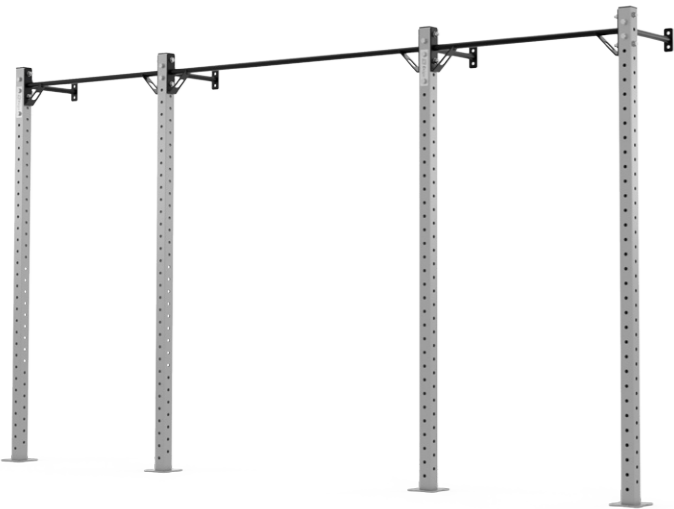

EXIGO X70 2 BAY COMPACT HIGH/LOW WALL RIG

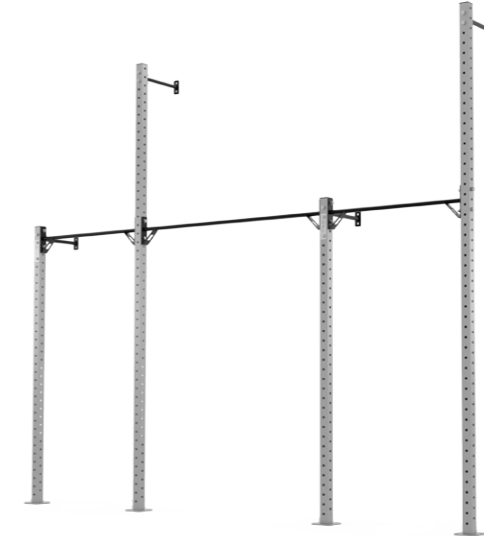

EXIGO X70 3 BAY COMPACT WALL RIG

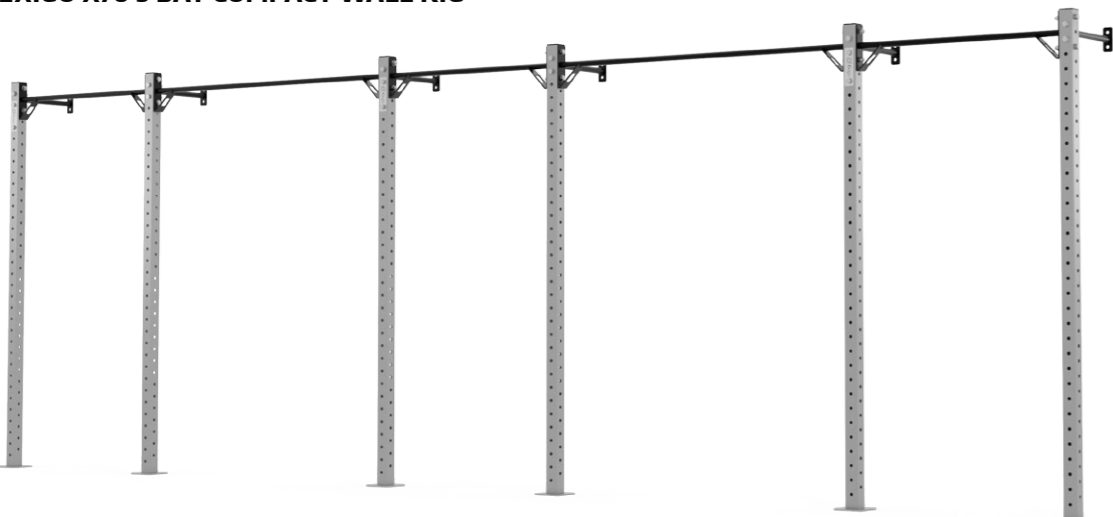

EXIGO X70 3 BAY COMPACT HIGH/LOW WALL RIG

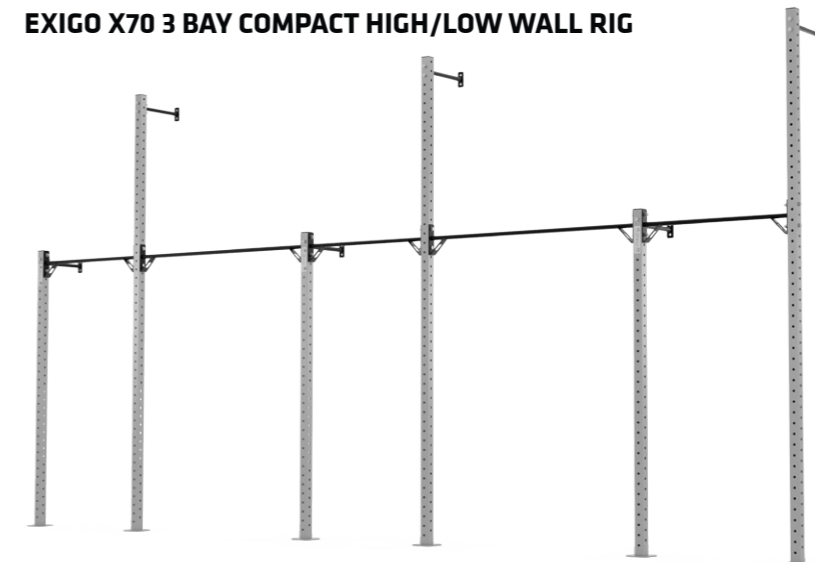

EXIGO X70 1 BAY MONKEY BAR WALL RIG



EXIGO X70 MULTI RIG



EXIGO X70 2 BAY MONKEY BAR WALL RIG



EXIGO X70 OCTA RIG



EXIGO X70 3 BAY MONKEY BAR WALL RIG



EXIGO X70 CORNER RIG



EXIGO X70 BRIDGE RIG (5M-10M)



EXIGO X70 HIGH/LOW BRIDGE RIG (5M-10M)



EXIGO X70 DUAL CABLE RIG



## ATTACHMENTS

SKU	PRODUCT
A-1505	J-HOOKS (PAIR)
A-1510	SAFETY SPOT ARMS (PAIR)
A-1515	LANDMINE
A-1520	DIP ATTACHMENT
A-1530	SINGLE LOOP
A-1535	HIP THRUST PAD
A-1540	SINGLE LEG SQUAT ROLLER
A-1545	HIGH LOW PULLEY CLAMP ON
A-1550	ANGLED PULL-UP BAR
A-1555	MULTI BALL GRIP PULL-UP BAR (PAIR)
A-1560	ADJUSTABLE PULL-UP HANDLES (PAIR)
A-1565	45 DEGREE WING 1100
A-1570	BAR STORAGE HOOK
A-1575	BAR STORAGE HOLDER
A-1580	CHALK BOWL
A-1585	BRANDING PLATE
A-1595	LADDER ATTACHMENT 1100
A-1600	LADDER ATTACHMENT 1760
A-1605	CONTINUOUS ROPE PULL
A-1610	PUNCH BAG ARM
A-1615	TARGET BOARD
A-1620	SHACKLE BRACKET
A-1625	TRAWLER ARM
A-1630	MONKEY BAR RAIL 32DIA 1100
A-1635	MONKEY BAR RAIL 32DIA 1760
A-1640	ANGLED MONKEY BAR RAIL 32DIA 1760
A-1642	MONKEY BAR RAIL 32DIA 2290 (MULTI / OCTA RIG)
A-1645	STEP PLATE
A-1650	MAT HANGER
A-1655	STORAGE HOOKS
A-1660	SKIERG MOUNT
A-1665	SKID PLATE (EACH)
A-1670	FLOOR MOUNTING PLATE (EACH)
A-1675	ADJUSTABLE JAMMER ARMS
A-1695	SAFETY STRAPS (PAIR)
A-1705	UNIVERSAL SINGLE SIDED WEIGHT HORN (1.5" Dia)
A-1710	DOUBLE SIDED OFFSET WEIGHT HORN (1.5" Dia)
A-1775	BRIDGE PUNCH BAG BRACKET
A-1780	BRIDGE ANGLED PULL-UP BAR
A-1785	BRIDGE MONKEY BAR TUBE 32DIA 1220



# INTERNAL STORAGE OPTIONS

**INTERNAL** **3 POSITIONS REQUIRED.**

## EXIGO RESISTANCE BAND RAIL

1100: S-2195 | 1760: S-2200

Occupies 3 positions and can only be placed in position 4. Available in two sizes and can be used to store resistance bands or similar items such as skipping ropes.

Accessories not included.



**AVAILABLE POSITIONS**

- 4** POSITION 4
- 3** REQUIRED
- 2** REQUIRED
- 1** NOT COMPATIBLE

SIZE	CAPACITY	WEIGHT
1100	A range of Resistance Bands	6 kg (14 lbs)
1760	A range of Resistance Bands	10 kg (22 lbs)

**INTERNAL** **3 POSITIONS REQUIRED.**

## EXIGO MAT HANGER

1100: S-2175 | 1760: S-2180

Occupies 3 positions and can only be placed in position 4. Available in two sizes and is designed to store 1.2m long exercise mats.

Accessories not included.



**AVAILABLE POSITIONS**

- 4** POSITION 4
- 3** REQUIRED
- 2** REQUIRED
- 1** NOT COMPATIBLE

SIZE	CAPACITY	WEIGHT
1100	Approx 20 Exercise Mats	5 kg (12 lbs)
1760	Approx 40 Exercise Mats	7 kg (16 lbs)

**INTERNAL** **1 POSITION REQUIRED.**

## EXIGO DUMBBELL/KETTLEBELL TRAY

1100: S-2145 | 1760: S-2150

Occupies only 1 position and can be placed in positions 1, 2 or 3. Available in two sizes and can be used to store dumbbells or kettlebells.

Accessories not included.



**AVAILABLE POSITIONS**

- 4** NOT COMPATIBLE
- 3** POSITION 3
- 2** POSITION 2
- 1** POSITION 1

SIZE	CAPACITY	WEIGHT
1100	Approx 3 pairs of Dumbbells Approx 8 Kettlebells	11 kg (25 lbs)
1760	Approx 7 pairs of Dumbbells Approx 16 Kettlebells	16 kg (36 lbs)

**INTERNAL** **1 POSITION REQUIRED.**

## EXIGO DUMBBELL RAIL WITH SADDLES

1100: S-2135 | 1760: S-2140

Occupies only 1 position and can be placed in positions 1, 2 or 3. Available in two sizes and is used to store dumbbells.

Accessories not included.



**AVAILABLE POSITIONS**

- 4** NOT COMPATIBLE
- 3** POSITION 3
- 2** POSITION 2
- 1** POSITION 1

SIZE	CAPACITY	WEIGHT
1100	2 pairs of Dumbbells	18 kg (40 lbs)
1760	4 pairs of Dumbbells	28 kg (62 lbs)

**INTERNAL** **1 POSITION REQUIRED.**

## EXIGO 1760 STUDIO BAR STORAGE

S-2210

Occupies only 1 position and can be placed in any of the 4 available positions. Only available for 1760 storage bays and is designed to hold studio barbells.

Accessories not included.



**AVAILABLE POSITIONS**

- 4** POSITION 4
- 3** POSITION 3
- 2** POSITION 2
- 1** POSITION 1

CAPACITY	WEIGHT
Approx 20 Studio Bars	8 kg (18 lbs)

**INTERNAL** **1 POSITION REQUIRED.**

## EXIGO STUDIO PLATE RAIL

1100: ES-2185 | 1760: ES-2190

Occupies only 1 position and can be placed in any of the 4 available positions. Available in two sizes and is used to store small studio plates.

Accessories not included.



**AVAILABLE POSITIONS**

- 4** POSITION 4
- 3** POSITION 3
- 2** POSITION 2
- 1** POSITION 1

SIZE	CAPACITY	WEIGHT
1100	Approx 20 Studio Weight Plates	6 kg (14 lbs)
1760	Approx 35 Studio Weight Plates	10 kg (22 lbs)

**INTERNAL** **1 POSITION REQUIRED.**

## EXIGO LARGE TRAY

1100: S-2125 | 1760: S-2130

Occupies only 1 position and can be placed in positions 1, 2 or 3. Available in two sizes and can be used to store various accessories of your choice.

Accessories not included.



**AVAILABLE POSITIONS**

- 4** NOT COMPATIBLE
- 3** POSITION 3
- 2** POSITION 2
- 1** POSITION 1

SIZE	CAPACITY	WEIGHT
1100	Various accessories	11 kg (25 lbs)
1760	Various accessories	22 kg (49 lbs)

**INTERNAL** **1 POSITION REQUIRED.**

## EXIGO LARGE BIN

1100: S-2115 | 1760: S-2120

Occupies 1 position and can only be placed in position 1. Available in two sizes and can be used to store various accessories of your choice.

Accessories not included.

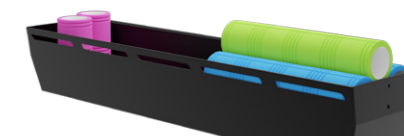

**AVAILABLE POSITIONS**

- 4** NOT COMPATIBLE
- 3** NOT COMPATIBLE
- 2** NOT COMPATIBLE
- 1** POSITION 1

SIZE	CAPACITY	WEIGHT
1100	Various accessories	23 kg (51 lbs)
1760	Various accessories	32 kg (71 lbs)

**INTERNAL** **1 POSITION REQUIRED.**

## EXIGO 300 BALL RAIL

1100: S-2165 | 1760: S-2170

Occupies only 1 position and can be placed in any of the 4 available positions. Available in two sizes and is used to store oversized medicine balls.

Accessories not included.

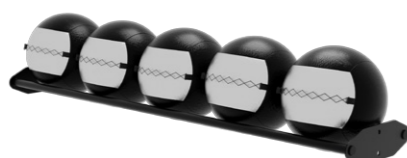

**AVAILABLE POSITIONS**

- 4** POSITION 4
- 3** POSITION 3
- 2** POSITION 2
- 1** POSITION 1

SIZE	CAPACITY	WEIGHT
1100	3 Oversized Medicine Balls	8 kg (18 lbs)
1760	5 Oversized Medicine Balls	10 kg (22 lbs)

**INTERNAL** **1 POSITION REQUIRED.**

## EXIGO 200 BALL RAIL

1100: S-2155 | 1760: S-2160

Occupies only 1 position and can be placed in any of the 4 available positions. Available in two sizes and is used to store medicine balls.

Accessories not included.



**AVAILABLE POSITIONS**

- 4** POSITION 4
- 3** POSITION 3
- 2** POSITION 2
- 1** POSITION 1

SIZE	CAPACITY	WEIGHT
1100	4 Medicine Balls	7 kg (16 lbs)
1760	6 Medicine Balls	9 kg (20 lbs)

**INTERNAL** **1 POSITION REQUIRED.**

## EXIGO TOAST RAIL

1100: S-2100 | 1760: S-2105

Occupies 1 position and can only be placed in position 1. Available in two sizes and is designed to store weight plates.

Accessories not included.



**AVAILABLE POSITIONS**

- 4** NOT COMPATIBLE
- 3** NOT COMPATIBLE
- 2** NOT COMPATIBLE
- 1** POSITION 1

SIZE	CAPACITY	WEIGHT
1100	Approx 250kg (10 x 25kg Plates)	12 kg (27 lbs)
1760	Approx 450kg (18 x 25kg Plates)	17 kg (38 lbs)

**INTERNAL**

## EXIGO TOAST RAIL TRAY

S-2110

Only compatible with the 1760 Toast Rail and is added to create a solid base for alternative accessories. Up to 3 can be added.

Toast Rail & Accessories not included.



**AVAILABLE POSITIONS**

- 4** N/A
- 3** N/A
- 2** N/A
- 1** N/A

CAPACITY	WEIGHT
Various accessories	8 kg (18 lbs)



## EXTERNAL STORAGE OPTIONS

EXTERNAL

4 POSITIONS REQUIRED.

### EXIGO SIDE MAT HANGER SINGLE: S-2300 | DOUBLE: S-2301

Occupies all 4 external positions and can only be placed in position 4. Available in two sizes and mounted on the outside of an upright to store exercise mats up to 1.6m long.

Accessories not included.



AVAILABLE POSITIONS

- 4 POSITION 4
- 3 REQUIRED
- 2 REQUIRED
- 1 REQUIRED

SIZE	CAPACITY	WEIGHT
SINGLE	Approx 20 Exercise Mats	5 kg (11 lbs)
DOUBLE	Approx 40 Exercise Mats	10 kg (22 lbs)

EXTERNAL

4 POSITIONS REQUIRED.

### EXIGO CORNER MAT HANGER S-2305

Occupies all 4 external positions and can only be placed in position 4. Stores exercise mats up to 1.6m long and allows your bay to be placed in the corner of a room.

Accessories not included.



AVAILABLE POSITIONS

- 4 POSITION 4
- 3 REQUIRED
- 2 REQUIRED
- 1 REQUIRED

CAPACITY	WEIGHT
Approx 20 Exercise Mats	7 kg (16 lbs)

EXTERNAL

4 POSITIONS REQUIRED.

### EXIGO BATTLE ROPE STORAGE S-2325

Occupies all 4 external positions and can only be placed in position 4. Mounted on the outside of an upright and is used to store battle ropes.

Accessories not included.



AVAILABLE POSITIONS

- 4 POSITION 4
- 3 REQUIRED
- 2 REQUIRED
- 1 REQUIRED

CAPACITY	WEIGHT
Approx 1 Battle Rope	2 kg (5 lbs)

EXTERNAL

3 POSITIONS REQUIRED.

### EXIGO VERTICAL DUMBBELL RACK S-2310

Occupies 3 external positions and can only be placed in position 3. Mounted on the outside of an upright and is used to store dumbbells.

Accessories not included.



AVAILABLE POSITIONS

- 4 POSITION 4
- 3 POSITION 3
- 2 REQUIRED
- 1 REQUIRED

CAPACITY	WEIGHT
3 pairs of Dumbbells	10 kg (22 lbs)

EXTERNAL

2 POSITIONS REQUIRED.

### EXIGO 400 SIDE BALL STORAGE S-2315

Occupies 2 external positions and can be placed in positions 1 or 3. Mounted on the outside of an upright and is used to store Swiss Balls.

Accessories not included.



AVAILABLE POSITIONS

- 4 REQUIRED
- 3 POSITION 3
- 2 REQUIRED
- 1 POSITION 1

CAPACITY	WEIGHT
1 Swiss Ball	4 kg (9 lbs)

EXTERNAL

2 POSITIONS REQUIRED.

### EXIGO SIDE BIN S-2320

Occupies 2 external positions and can be placed in positions 1 or 3. Mounted on the outside of an upright and is used to store small accessories of your choice.

Accessories not included.



AVAILABLE POSITIONS

- 4 REQUIRED
- 3 POSITION 3
- 2 REQUIRED
- 1 POSITION 1

CAPACITY	WEIGHT
Various small accessories	12 kg (27 lbs)





©2024 Exigo. All Rights Reserved.